

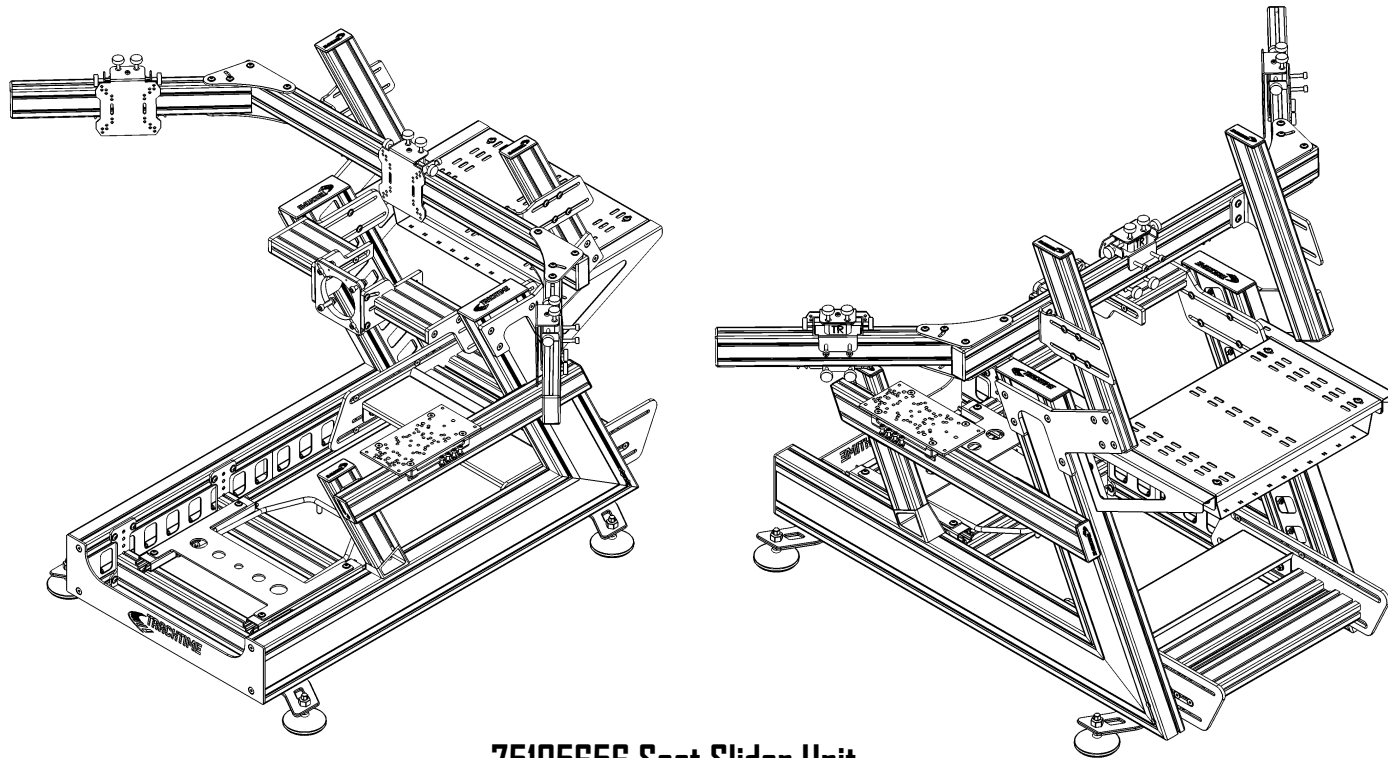

series / one



75105656 Seat Slider Unit

Version 2

BEFORE STARTING THE BUILD

The following are needed for assembly:

- Soft base / underlay (scratch protection)
- A set of hex wrenches
- Ratchet with 13mm nut
- Hammer (mallet)
- Tape measure/ruler
- A buddy who can lend a hand

Read the manual first. All remarks are important and could help you avoid problems.

Use BOM (Bill of Material) to find the sizes and lengths of the parts.



3 / 9



Install the four (E5) T-nuts.

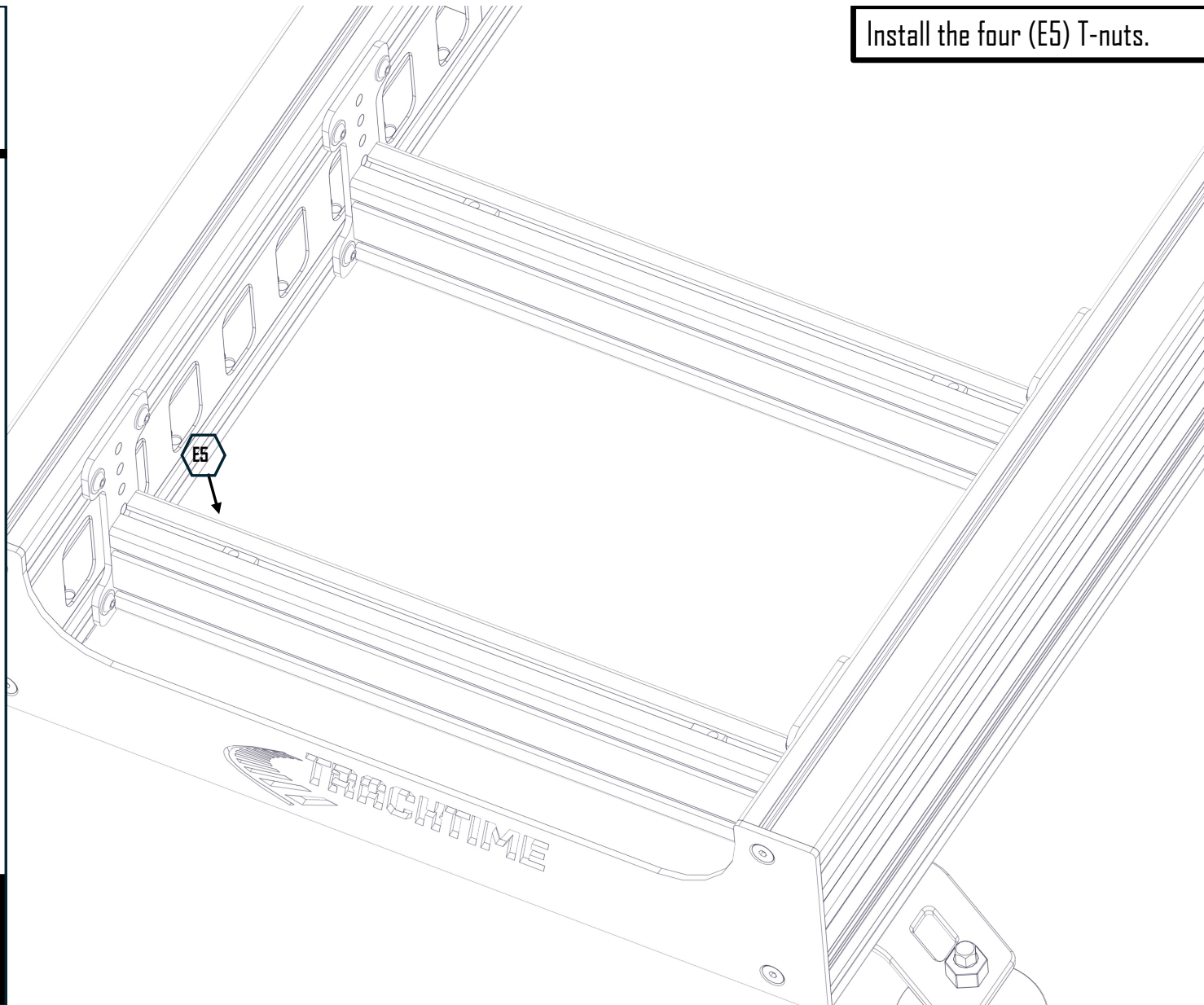

SEATSLIDER +
SEATCONSOLE

4 / 9



Unfold the seat slider unit and assemble the three main parts as shown in the diagram. The screws provided in the box are not required and can be used for other purposes.

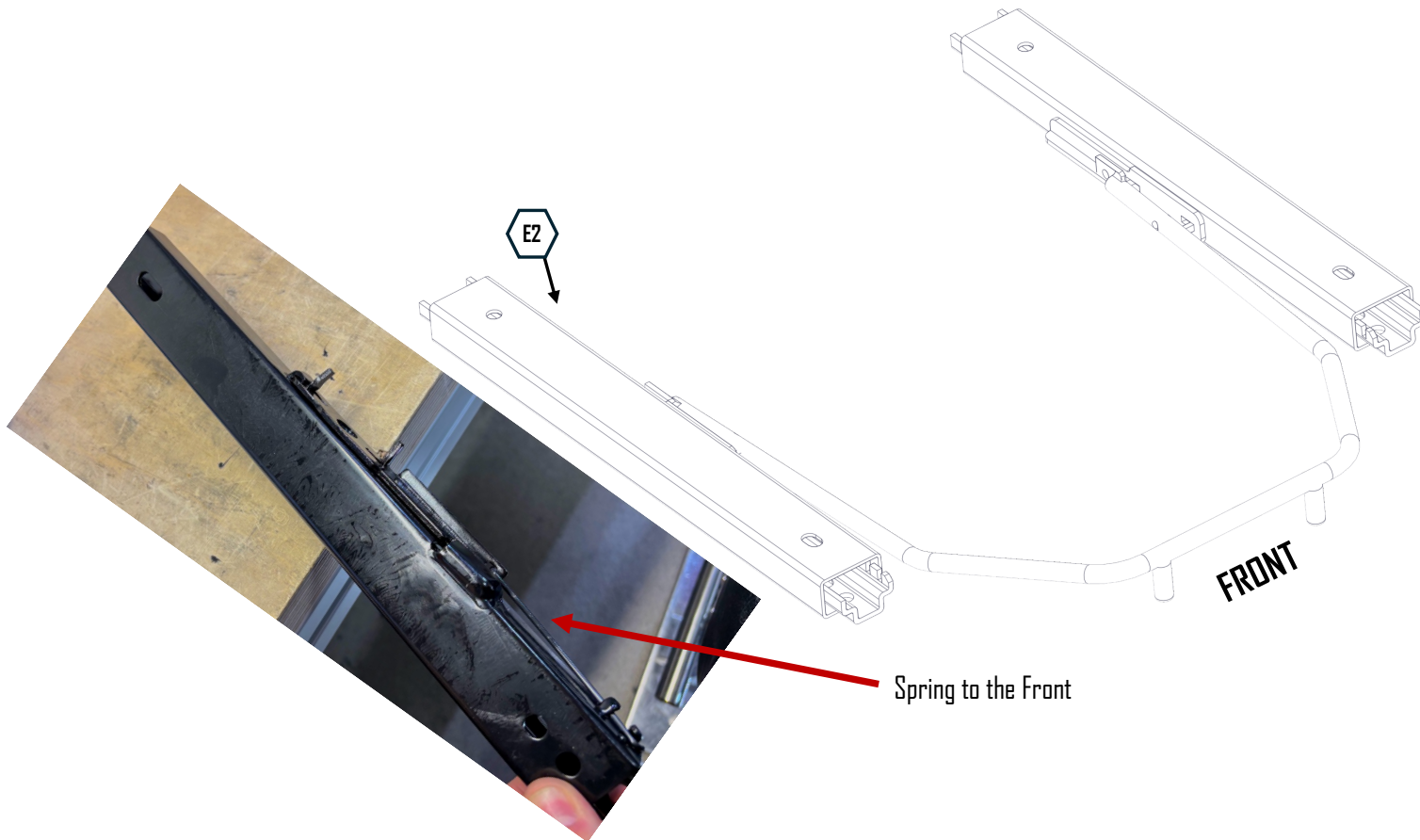

SEATSLIDER +
SEATCONSOLE

5 / 9

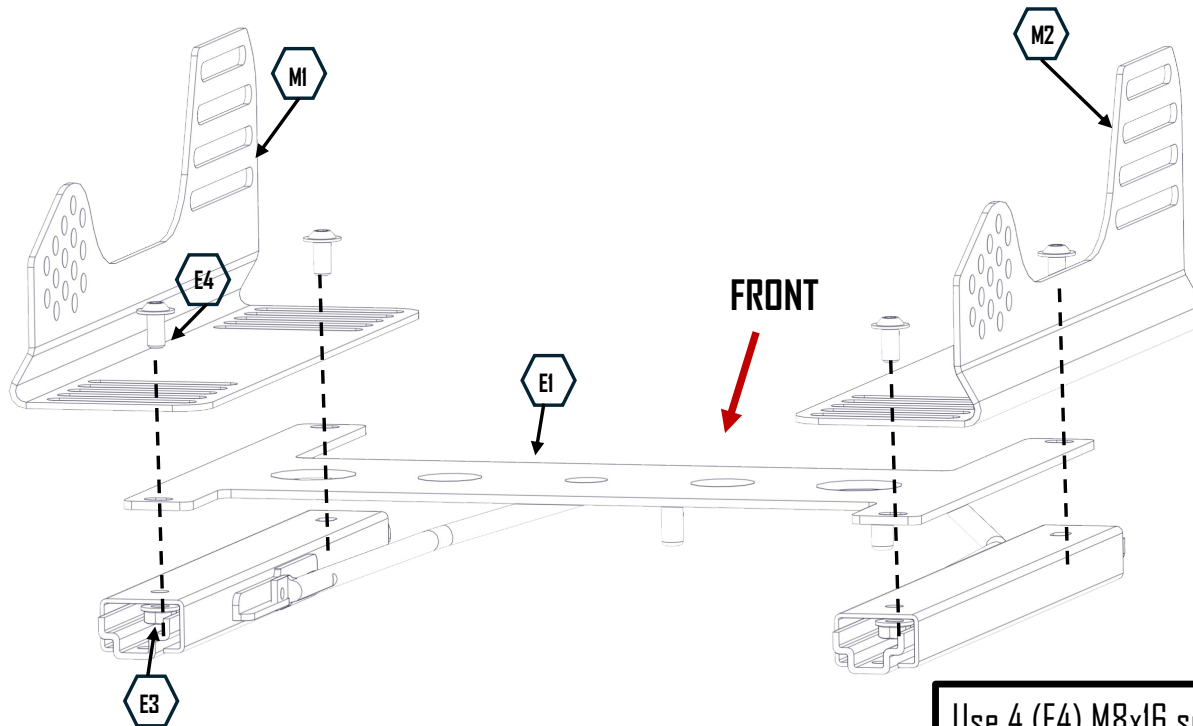
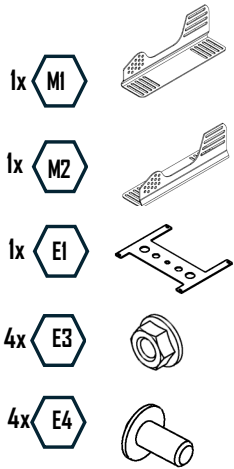

In order to reach the mounting holes, the seat slider may need to be operated. If needed Unlock one side of the seat slider using the handgrip, then move the slider as far as necessary to access the hole. You will feel the slider lock into place at defined intervals. Make sure that you move both sliders (left and right) by the same amount.

Use 4 (E4) M8x16 screws and 4 (E3) nuts to screw all units together. Do not tighten these screws yet, as you will do so when you mount the seat.

SEATSLIDER +
SEATCONSOLE

6 / 9

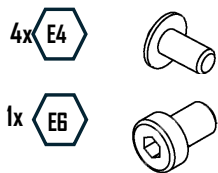

SEATSLIDER +
SEATCONSOLE

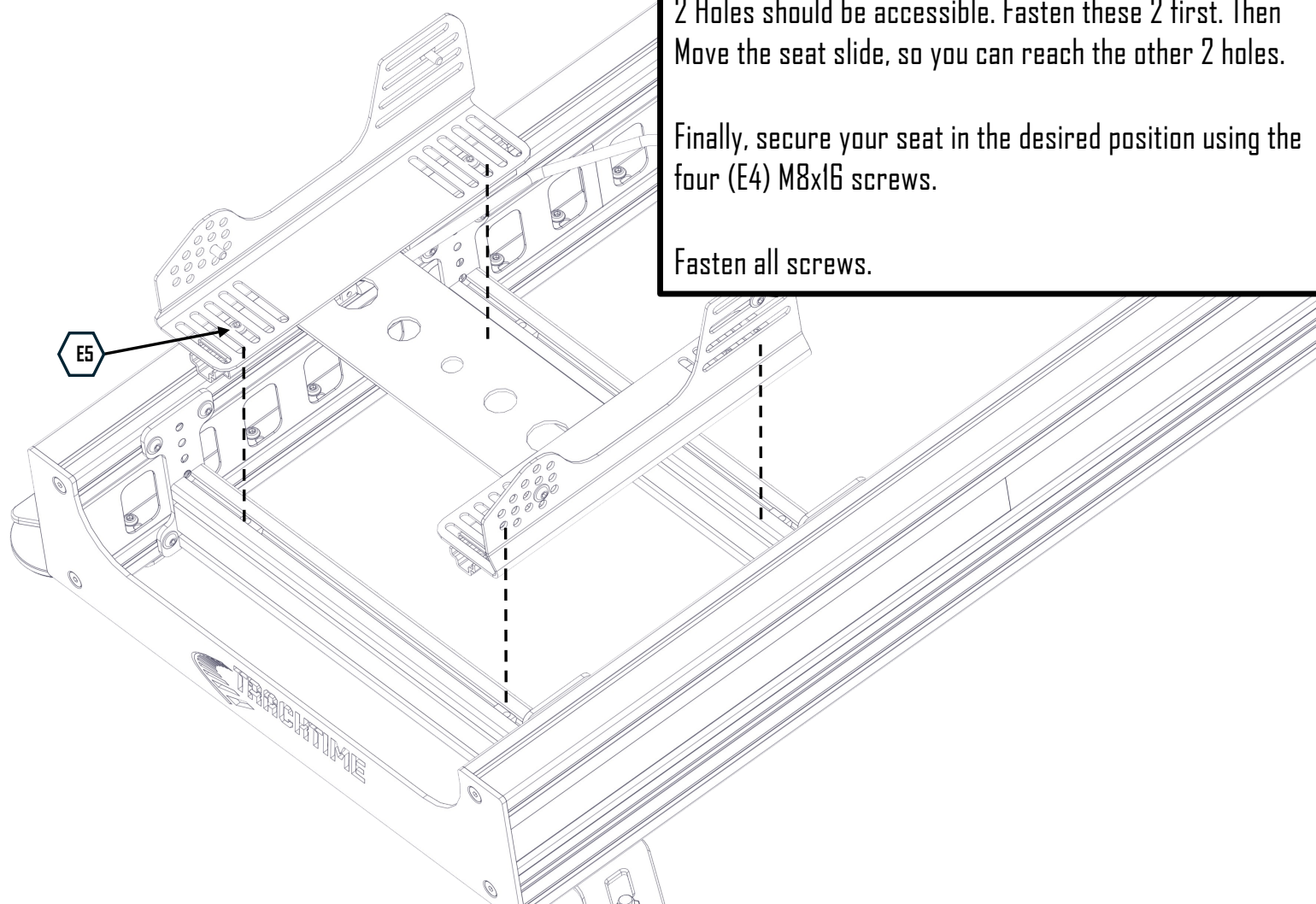

Mount the unit to the frame using four (E6) M8x12 cylinder screws.

2 Holes should be accessible. Fasten these 2 first. Then Move the seat slide, so you can reach the other 2 holes.

Finally, secure your seat in the desired position using the four (E4) M8x16 screws.

Fasten all screws.



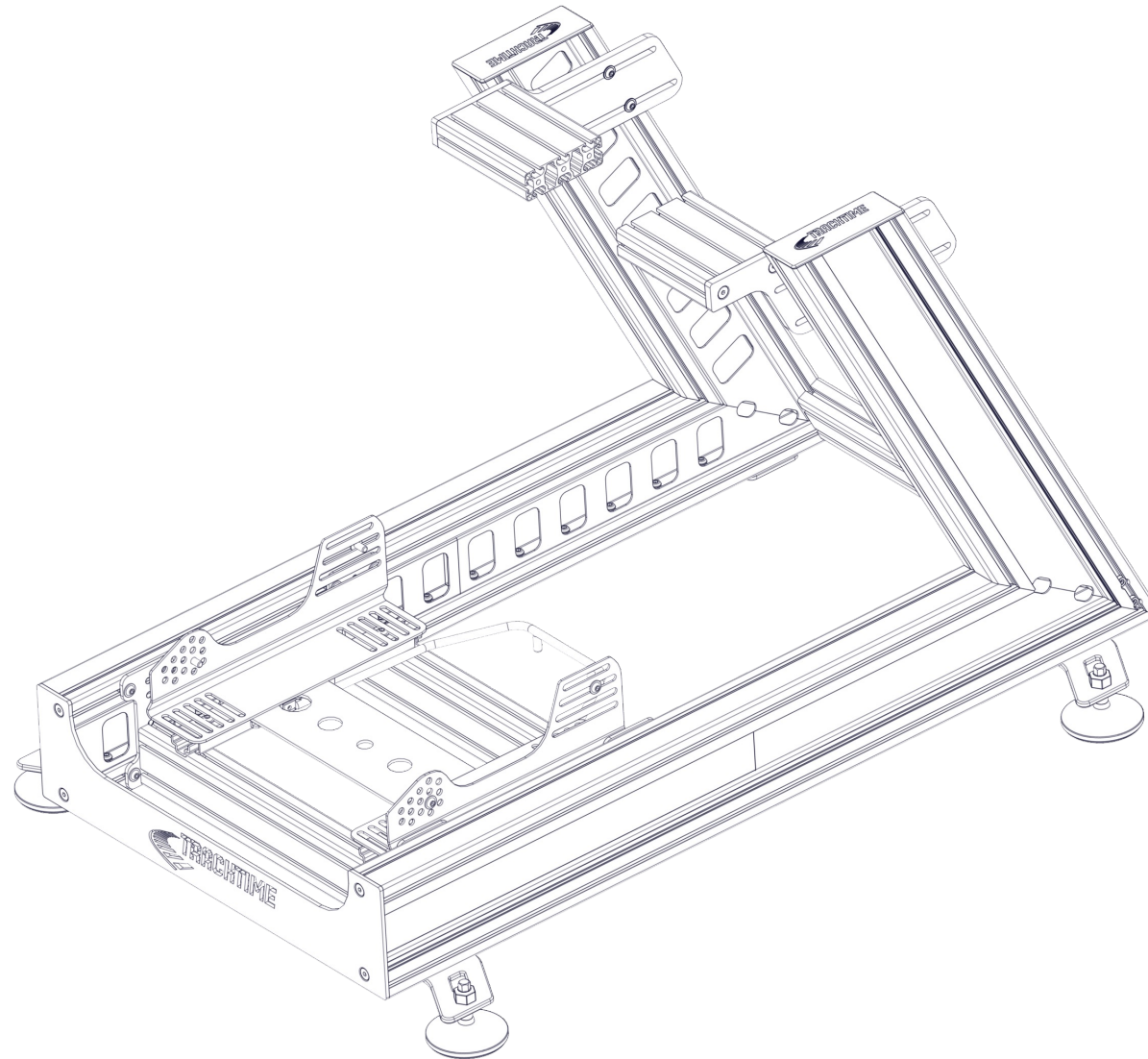

7 / 9

SEATSLIDER +
SEATCONSOLE

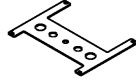

Finished sliding seat holder unit.

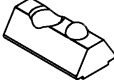

75105656 Adjustable Seat Unit

Part	Picture	Order. No.	Article	Pieces	Part	Picture	Order. No.	Article	Pieces
E1		75121154	Support Bracket	1	E4		68320244	Lensflatscrew M8x16	4
E2		75105380	Seat Slider	1	E5		75190016	T-Nut M8	4
E3		68310044	Lock Nut M8	4	E6		68320134	Cylinderscrew M8x12	4

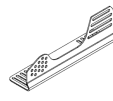
75105338 SEAT CONSOLE

Part	Picture	Order. No.	Article	Pieces
M1		75120742	Seat Console Left	1
M2		75120743	Seat Console Right	1
M3		68320244	Lensflatscrew MBx16	8



series / one

Need help? Scan for help & resources



If you have any further questions about assembling this product or about the manual itself, please contact our support department. You can reach them at

info@track-time.de